

PEZZI DI RICAMBIO

Hindi880[®] .Evo

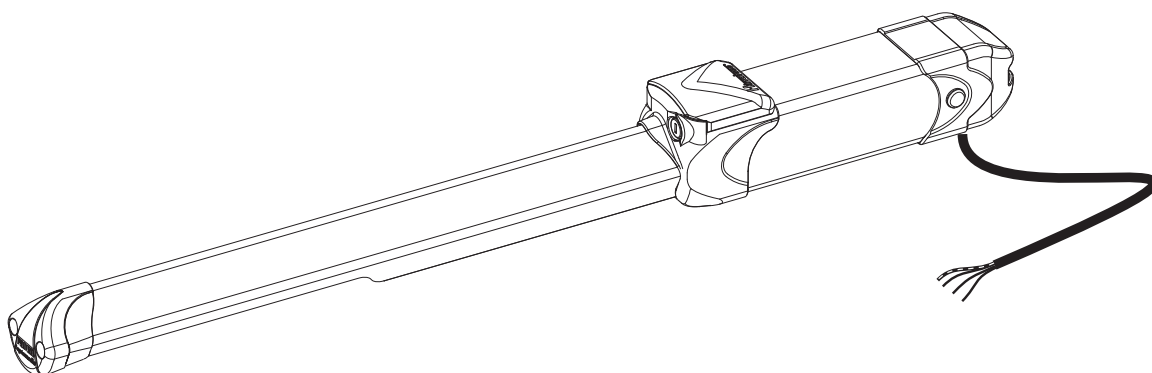









IT

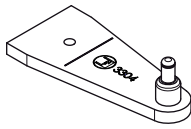
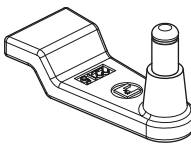

FADINI
l'apricancello
Made in Italy

Dis. N. 7601

87001 = codice **nuovo**
 [88073] = codice **vecchio**

RIF. ARTICOLO	FIGURA	POSIZIONE	DENOMINAZIONE	QUANTITA'	CODICE D'ORDINE
87001 [88073]		1	Piastra di attacco stelo per corsa 400 mm	1	87157
87002 [88008]		2	Piastra di attacco stelo per corsa 150 e 280 mm	1	87156
87003 [88009]		3	Testa sferica	1	87158
87004 [88010]		4	Seeger E12	1	87156
87005 [88011]		5	Dado M12	1	87158
87006 [88012]		6	Seeger J30	1	87143
87007 [88013]		7	Rondella distanziatrice da 30	1	87143
87008 [88016]		8	Guarnizione stelo da 20	1	87155
87009 [88014]		9	Dado M6 lungo di fissaggio tiranti del cofano	2	87143
87010 [88015]		10	Dado M6	2	87143









FADINI[®]
l'apricancello

87011 = codice nuovo
[88017] = codice vecchio

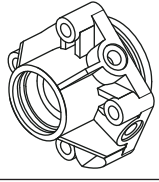
HINDI 880 - EVO

SP.K22

PEZZI DI RICAMBIO

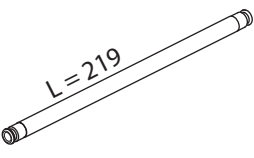
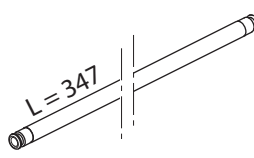
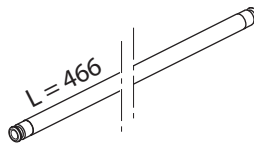
87011 [88017]		11	Tappo antivibrante del cofano	3	87143
87012 [88018]		12	Testa pistone senza freno	1	87143
87013 [88048]		13	OR 3156	2	87155
87014 [88079]		14	OR 2018	2	87155
87015 [88074]		15	Registro del freno sulla testa	1	87154
87016 [88086]		16	Riduttore flusso olio	1	87145
87017 [88046]		17	OR 2025	6	87155
87018 [88087]		18	OR 2010	1	87155
87019 [880122]		19	Tubetto di mandata olio per corsa 150 mm	1	87144
87020 [88022]		20	Tubetto di mandata olio per corsa 280 mm	1	87145
87021 [880113]		21	Tubetto di mandata olio per corsa 400 mm	1	87146

Le immagini riportate in questo listino sono puramente indicative.



FADINI[®]
l'apricancello

87022 = codice nuovo
[88050] = codice vecchio

HINDI 880 - EVO

SP.K22

PEZZI DI RICAMBIO

87022 [88050]		22	Chiave tubolare a "G"	1	87156
87023 [880123]		23	Stelo con stantuffo per corsa 150 mm senza freno	1	87147
87024 [88092]		24	Guarnizione completa per stantuffo Ø 45	1	87155
87025 [880125]		25	Tirante M6x230 per corsa 150 mm	6	87025
87026 [880124]		26	Camicia pistone per corsa 150 mm	1	87026
87027		27	Cursore del freno in chiusura	1	87148
87028		28	Stelo con stantuffo e molle per la frenatura in apertura e in chiusura, per corsa 280 mm	1	87148
87029		29	Tappo per frenatura in apertura	1	87148
87030 [88019]		30	Stelo con stantuffo per corsa 280 mm senza freno	1	87149
87031 [88007]		31	Tirante M6x365 per corsa 280 mm	6	87031
87032 [88020]		32	Camicia pistone per corsa 280 mm	1	87032

Le immagini riportate in questo listino sono puramente indicative.



FADINI[®]
l'apricancello

87034 = codice nuovo
[880114] = codice vecchio

HINDI 880 - EVO

SP.K22

PEZZI DI RICAMBIO

87033		33	Stelo con stantuffo e molle per la frenatura in apertura e in chiusura, per corsa 400 mm	1	87150
87034 [880114]		34	Stelo con stantuffo per corsa 400 mm senza freno	1	87151
87035 [880116]		35	Tirante M6x490 per corsa 400 mm	5	87035
87036 [880115]		36	Camicia pistone per corsa 400 mm	1	87036
87037 [88001]		37	Dado M6 cieco	2	87037
87038 [880134]		38	Tappo di chiusura cofano	1	87038
87039 [880147]		39	Cofano in alluminio anodizzato per corsa 150 mm	1	87039
87040 [880148]		40	Cofano in alluminio anodizzato per corsa 280 mm	1	87040
87041 [880149]		41	Cofano in alluminio anodizzato per corsa 400 mm	1	87041
87042 [880140]		42	Chiave cifrata WA7001	2	87042
87043		43	Blocchetto serratura WA7001	1	87152









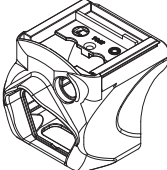

FADINI®
l'apricancello

87044 = codice nuovo
[880136] = codice vecchio

HINDI 880 - EVO

SP.K22

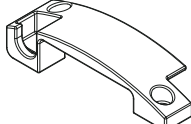
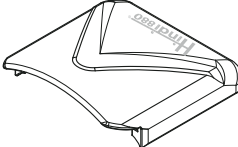
PEZZI DI RICAMBIO

87044 [880136]		44	Cassa cilindro serratura	1	87152
87045 [880135]		45	Carter di copertura valvola	1	87152
87046 [88005]		46	Vite M5x16 TSEI inox	1	87152
87047 [880139]		47	Levetta di lunghezza 15 mm	1	87152
87048 [880138]		48	Seeger da 8 di fissaggio levetta	1	87152
87049 [880144]		49	Vite 2,9x6,5 TSC autoflettante nichelata	2	87152
87050 [880146]		50	Pulsante di aiuto apertura cassetto scorrevole	1	87152
87051 [880145]		51	Molla di aiuto apertura cassetto scorrevole	1	87152
87052 [880143]		52	Battuta di fermo cassetto scorrevole	1	87152
87053 [880142]		53	Cassetto scorrevole	1	87152
87054 [88024]		54	Vite M6x20 TEI inox	8	87054











FADINI[®]
l'apricancello

87058 = codice **nuovo**
[88043] = codice **vecchio**

HINDI 880 - EVO

SP.K22

PEZZI DI RICAMBIO

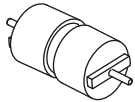
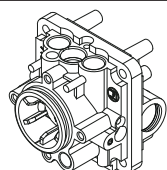
87055		55	Tappo by-pass valvola sempre libera	2	87153
87056		56	Bicchiere di resistenza in chiusura per valvola sempre libera	1	87153
87057		57	OR 2021	1	87155
87058 [88043]		58	Tappo laterale di blocco	1	87153
87059 [88044]		59	OR 119	2	87155
87060 [88077]		60	Molla conica del blocco 0,35x7,2x12	2	87153
87061 [88080]		61	Sfera Ø 6,35 inox	2	87153
87062 [88041]		62	Sede valvola di ritenuta	2	87153
87063 [88045]		63	OR 117	2	87155
87064 [88040]		64	Cilindretto bidirezionale	1	87153
87065		65	Valvola Hindi-evo	1	87153

Le immagini riportate in questo listino sono puramente indicative.











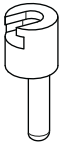

FADINI[®]
l'apricancello

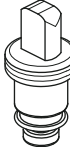
87067 = codice nuovo
[88037] = codice vecchio

HINDI 880 - EVO

SP.K22

PEZZI DI RICAMBIO

87066		66	Vite M5x10 TSP inox	2	87153
87067 [88037]		67	Cuffia protezione a tappo	1	87155
87068 [88036]		68	OR 108	1	87155
87069 [88035]		69	Registro di sblocco	1	87153
87070		70	Registro freno in apertura	1	87153
87071 [88075]		71	Distanziale di fermo registro di sblocco <i>(non si usa più)</i>	1	
87072 [88029]		72	Pastiglia in nylon per valvola di massima pressione	2	87153
87073 [88030]		73	Molla a compressione 1,2x7,2x29	2	87153
87074 [88031]		74	Sfera Ø 6,35	2	87153
87075 [88032]		75	OR 2043	3	87155
87076 [88033]		76	Registro verde di massima pressione in apertura	1	87153

Le immagini riportate in questo listino sono puramente indicative.







FADINI[®]
l'apricancello

87077 = codice nuovo
[88033] = codice vecchio

HINDI 880 - EVO

SP.K22

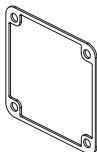
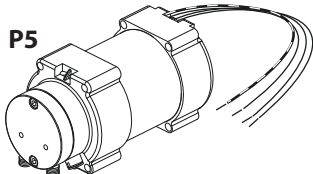
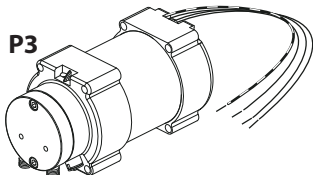
PEZZI DI RICAMBIO

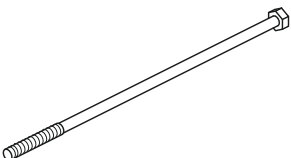
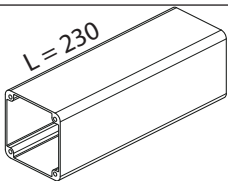
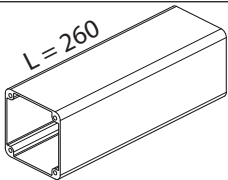
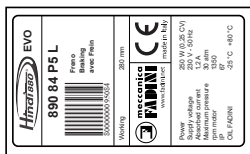
87077 [88033]		77	Registro rosso di massima pressione in chiusura	1	87153
87078 [88034]		78	Chiave di sblocco	1	87078
87079 [88027]		79	OR 2015	2	87155
87080 [88059]		80	Guarnizione di tenuta serbatoio	2	87155
87081 [88097]		81	Motore elettrico 230 V - 0,25 CV - P5 completo di art: 99-100-101-102-103-104-105-106-107-109	1	87081
87082 [88096]		82	Motore elettrico 230 V - 0,25 CV - P3 completo di art: 99-100-101-102-103-104-105-106-107-108	1	87082
87083		83	Rondella Ø 5	4	87083
87084 [88057]		84	Tirante di fissaggio motore M5x155 TE	4	87084
87085 [88060]		85	Serbatoio olio per corsa 150 e 280 mm	1	87085
87086 [880117]		86	Serbatoio olio per corsa 400 mm	1	87086
87087		87	Etichetta dati tecnici	1	87087

Le immagini riportate in questo listino sono puramente indicative.









FADINI®
l'apricancello

87088 = codice nuovo
[88061] = codice vecchio

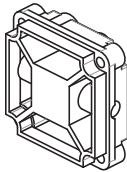
HINDI 880 - EVO

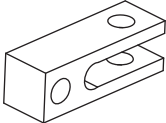
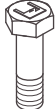

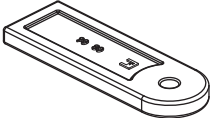
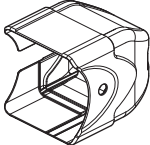
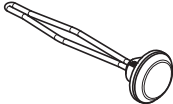

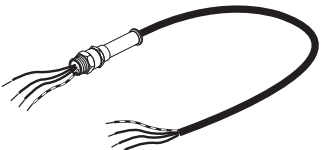

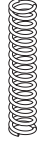

SP.K22

PEZZI DI RICAMBIO

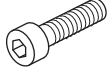





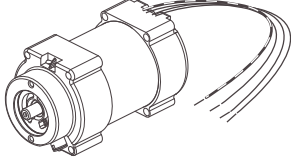
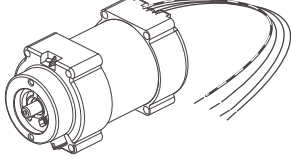

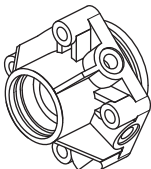

87088 [88061]		88	Morsetto a cappuccio per i cavi elettrici	4	87088
87089 [88062]		89	Fondello pistone	1	87089
87090 [88063]		90	Spina elastica 10x65 di fermo coda a forcella	1	87090
87091 [88066]		91	Coda a forcella di attacco posteriore	1	87091
87092 [88065]		92	Vite M12x40 TE	1	87156
87093 [88069]		93	Dado M12 autobloccante	1	87156
87094 [88067]		94	Piastra forata di attacco posteriore	1	87156
87095 [880131]		95	Cuffia di copertura fondello	1	87095
87096 [880132]		96	Borchia di chiusura cuffia	1	87096
87097 [880133]		97	Passacavo	1	87097
87098 [88068]		98	Cavo elettrico 4x1 - 0,5VVF completo di attacco filettato e resinato. Lunghezza utile 80 cm	1	87098

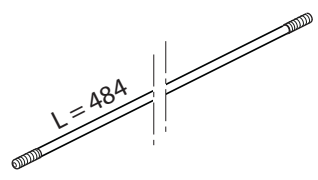
Le immagini riportate in questo listino sono puramente indicative.

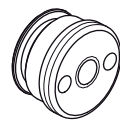

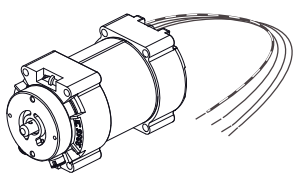
87099		99	Grano di aspirazione/scarico olio della piastrina della pompa	2	87081
87100		100	Molla di aspirazione 0,5x3,8x20	2	87081
87101		101	Rullino 6x6	2	87081
87102		102	Vite M5x20 TEI	2	87081
87103		103	Vite trilobata M3x6 TCC	1	87081
87104		104	Piastrina pompa	1	87081
87105		105	Girotrone completo della pompa P3	1	87081
87106		106	Girotrone completo della pompa P5	1	87081
87107		107	Spina Ø 3x9,5 <i>• n° 1 pz. per motore con pompa P3 - P5</i> <i>• n° 3 pz. per motore con pompa P10</i>	1	87081
87108		108	Motore 230 V - 0,25 CV completo di scudi per pompa P3	1	87082
87109		109	Motore 230 V - 0,25 CV completo di scudi per pompa P5	1	87081

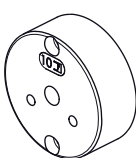

87110		110	Testa pistone predisposto per il freno	1	87154
87111		111	Grano M6x10 inox con codolo	1	87153
87112		112	Tirante M6x484 per corsa 400 mm	1	87112
87113		113	Sfera Ø 3,9	1	87153
87114		114	Molla a compressione 0,3x3,5x10	1	87153
87115		115	Tappo con foro di sfiato	1	87153
87116		116	Grano M5x5 zincato	1	87153
87117		117	Motore 230 V - completo di scudi per pompa P10	1	87123
87118		118	Girotrone completo della pompa P10	1	87123
87119		119	Campana in ghisa sp. 23 mm	1	87123
87120		120	OR 2056	2	87123

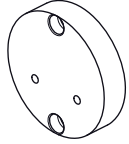
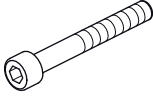
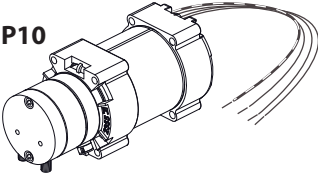

87121		121	Piastrina pompa P10	1	87123
87122		122	Vite M5x40 TEI	2	87123
87123		123	Motore elettrico 230 V - 0,25 CV - P10 completo di art: 99-100-101-103-107-117-118-119-120- 121-122	1	87123
		124			
		125			
		126			
		127			
		128			
		129			
		130			
		131			

Le immagini riportate in questo listino sono puramente indicative.

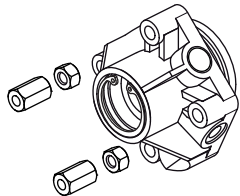
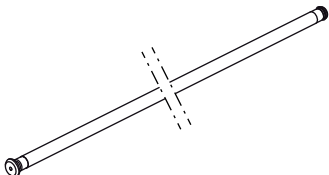
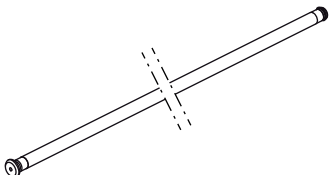
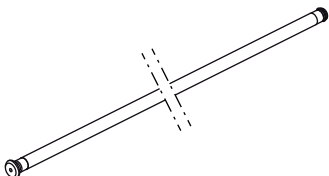
RIF. ARTICOLO	FIGURA	DENOMINAZIONE	CODICE D'ORDINE
87143		Testa pistone <u>senza freno</u> completa di art: 6-7-8-9-10-11-12-13	87143
87144		Tubetto di mandata olio per corsa <u>150 mm</u> completo di art: 16-17-18-19	87144
87145		Tubetto di mandata olio per corsa <u>280 mm</u> completo di art: 16-17-18-20	87145
87146		Tubetto di mandata olio per corsa <u>400 mm</u> completo di art: 16-17-18-21	87146

Le immagini riportate in questo listino sono puramente indicative.

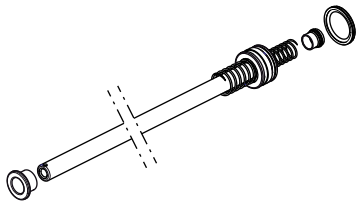
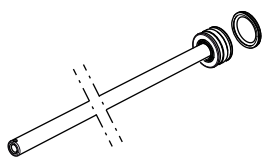
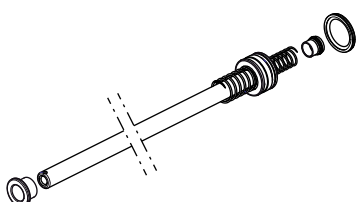
RIF. ARTICOLO	FIGURA	DENOMINAZIONE	CODICE D'ORDINE
87147 [880123]		Stelo con stantuffo <u>senza freno</u> per corsa <u>150 mm</u> completo di art: 23-24	87147
87148 [88099]		Stelo con stantuffo <u>per freno</u> per corsa <u>280 mm</u> completo di art: 24-27-28-29	87148
87149 [880110]		Stelo con stantuffo <u>senza freno</u> per corsa <u>280 mm</u> completo di art: 24-30	87149
87150 [880118]		Stelo con stantuffo <u>per freno</u> per corsa <u>400 mm</u> completo di art: 24-27-29-33	87150

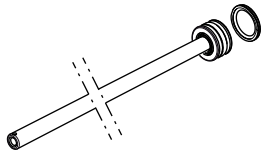
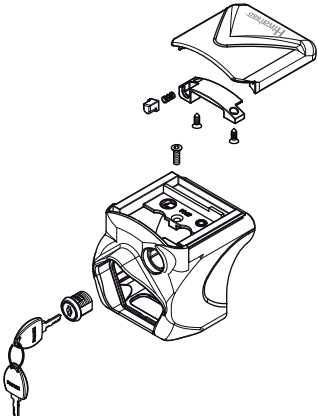
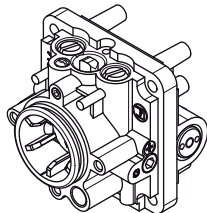
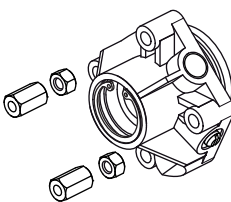
RIF. ARTICOLO	FIGURA	DENOMINAZIONE	CODICE D'ORDINE
87151 [880114]		Stelo con stantuffo <u>senza freno</u> per corsa <u>400 mm</u> completo di art: 24-34	87151
87152 [880155]		Gruppo con chiavi, carter di copertura valvola e cassetto scorrevole, completo di art: 42-43-44-45-46-47-48-49-50-51-52-53	87152
87153		Valvola completa di art: 17-55-56-57-58-59-60-61-62-63-64-65-66-67-68- 69-70-72-73-74-75-76-77-79-111-113-114-115- 116	87153
87154		Testa pistone <u>per freno</u> completa di art: 6-7-8-9-10-11-13-14-15-110	87154

RIF. ARTICOLO	FIGURA	DENOMINAZIONE	CODICE D'ORDINE
87155		Confezione serie guarnizioni, completa di art: 8-13-14-17-18-24-57-59-63-67-68-75-79-80	87155
87156		Confezione piastre di attacco, completa di art: 2-4-22-78-92-93-94 150 - 280 mm	87156
87157		Confezione piastre di attacco, completa di art: 1-4-22-78-92-93-94 400 mm	87157
880111		Confezione serie guarnizioni Hindi 880 <i>(per versione antecedente a Hindi 880 evo)</i>	880111

Le immagini riportate in questo listino sono puramente indicative.

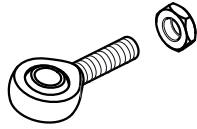

RIF. ARTICOLO	FIGURA	DENOMINAZIONE	CODICE D'ORDINE
87158		Testa sferica completa di dado M12, art: 3-5	87158

Le immagini riportate in questo listino sono puramente indicative.