

PEZZI DI RICAMBIO

Fibo 400

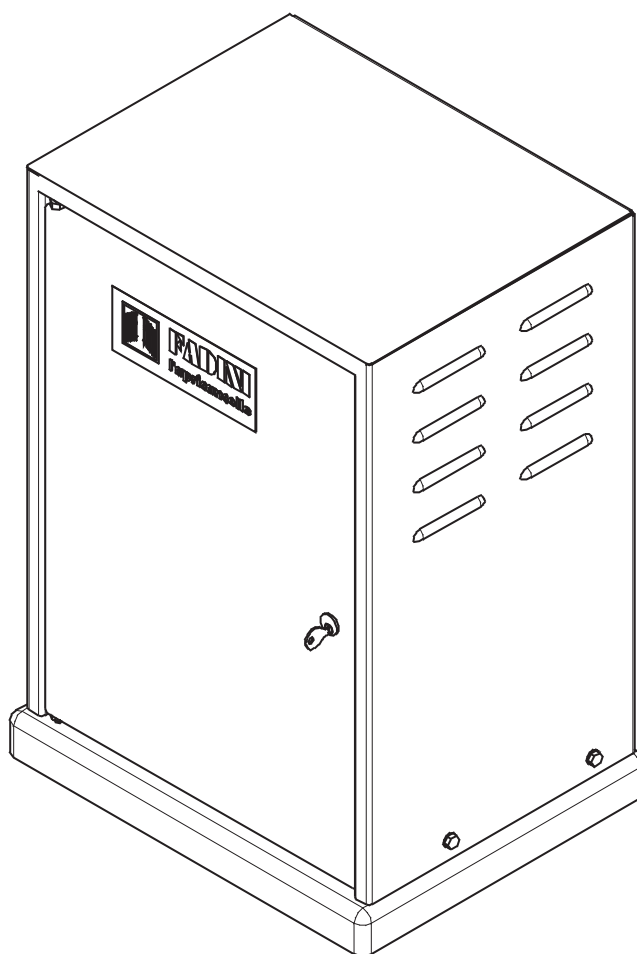









IT

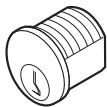



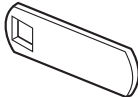

FADINI
l'apricancello
Made in Italy

Dis. N. 3782

RIF. ARTICOLO	FIGURA	POSIZIONE	DENOMINAZIONE	QUANTITA'	CODICE D'ORDINE
40001		1	Dado M8	10	40005
40002		2	Vite M8x20 TEI	2	40005
40003		3	Chiave serratura	2	40005
40004		4	Cilindretto serratura	1	40005
40005		5	Portiera cofano	1	40005
40006		6	Adesivo "Fadini l'apricancello"	1	40005
40007		7	Dado M20 E24 serratura	1	40005
40008		8	Levetta dritta serratura	1	40005
40009		9	Vite M5x4 TC serratura	1	40005
40010		10	Dado M22 autobloccante	1	40061

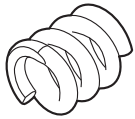





Le immagini riportate in questo listino sono puramente indicative.



40011		11	Rondella spingimolla	2	40061
40012		12	Molla di frizione 11x52x50	1	40061
40013		13	Anello seeger E42	1	40061
40014		14	Dado M12	4	40061
40015		15	Rosetta dentata ø 12 - forma A	4	40061
40016		16	Rondella ø 12	12	40061
40017		17	Vite M12x40 TE	4	40061
40018		18	Vite M12x20 TEI	4	40061
40019		19	Staffa angolare di attacco	2	40061
40020		20	Vite M8x25 TEI	8	40061
40021		21	Vite M8x55 TEI	2	40061



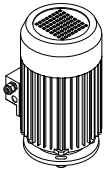

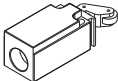



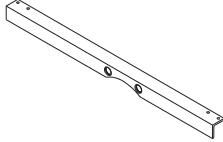

Le immagini riportate in questo listino sono puramente indicative.



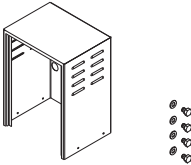

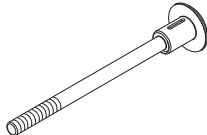
40022		22	Guarnizione OR 2425	1	40061
40023		23	Giunto dentato riduttore	1	40061
40024		24	Guarnizione OR 3156	1	40061
40025		25	Vite M8x35 TEI	4	40061
40026		26	Flangia di attacco motore	1	40061
40027		27	Anello di tenuta 55x80x8 L	1	40061
40028		28	Chiavetta 8x7x35	1	40030
40029		29	Rondella ø 8	12	40030
40030		30	Motore elettrico 3,0 CV	1	40030
40031		31	Vite M5x35 TEI	6	40062
40032		32	Fincorsa di comando NC, contatto singolo (sostituito con codice d'ordine 40062)	2	40062

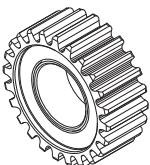
Le immagini riportate in questo listino sono puramente indicative.

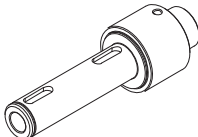

40033		33	Angolare di attacco finecorsa	1	40033
40034		34	Vite M12x20 TE	2	40034
40035		35	Chiavetta 12x8x40	2	40061
40036		36	Vite M8x10 TE inox	6	40037
40037		37	Gambale cofano	1	40037
40038		38	Chiavetta 6x6x35	1	40061
40039		39	Albero di trasmissione	1	40061
40040		40	Disco frizione	1	40067
40041		41	Ingranaggio di trascinamento Z24	1	40068
40042		42	Disco frizione ingranaggio	1	40067
40043		43	Mozzo di trascinamento	1	40061

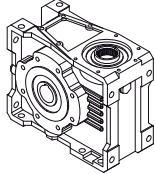
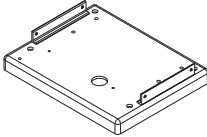
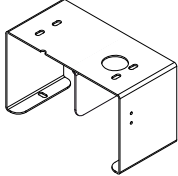

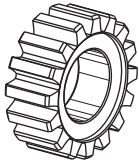
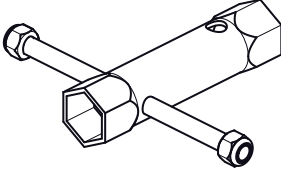
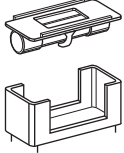
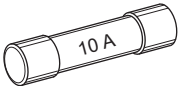
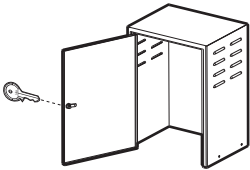
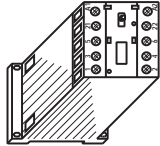
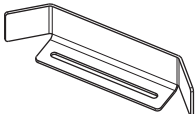
40044		44	Riduttore	1	40061
40045		45	Basamento	1	40045
40046		46	Supporto quadro	1	40066
40047		47	Bronzina ingranaggio	1	40068
40048		48	Ingranaggio Z16 - m6,0 con bronzina	1	40048
40049		49	Chiave di sblocco a tubo E 30-32	1	40049
40050		50	Porta fusibile e fusibile da 5 A	1	40050
40051		51	Fusibile istantaneo da 10 A	1	40051
40052		52	Cofano Fibo 400 completo di portiera, serratura V1 e cerniere	1	40052
40053		53	Teleruttore di potenza	1	40053
40054		54	Asole di finecorsa singole <i>(non si usa più)</i>	2	

Le immagini riportate in questo listino sono puramente indicative.

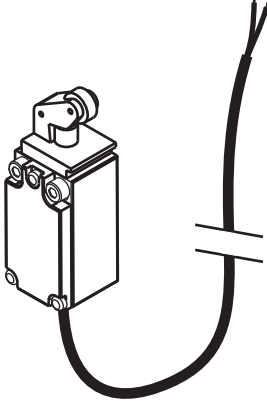
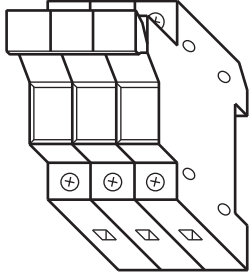
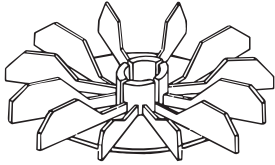
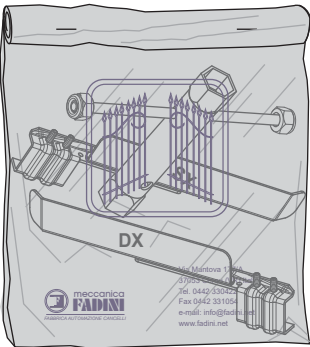
RIF. ARTICOLO	FIGURA	DENOMINAZIONE	CODICE D'ORDINE
40055		Interruttore di stacco tensione per portiera cofano e cavo elettrico da 800 mm <i>(sostituito con codice d'ordine 40063)</i>	40063
40056		Supporto a scatto per porta fusibili	40056
40057		Ventola di raffreddamento motore elettrico da CV 3,0 dis. 3298	40057
40058		Chiave di sblocco a tubo E 30-32 con n° 1 staffa fincorsa destra e n° 1 sinistra	40058

Le immagini riportate in questo listino sono puramente indicative.

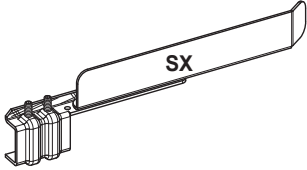
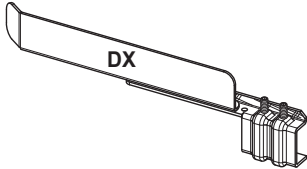
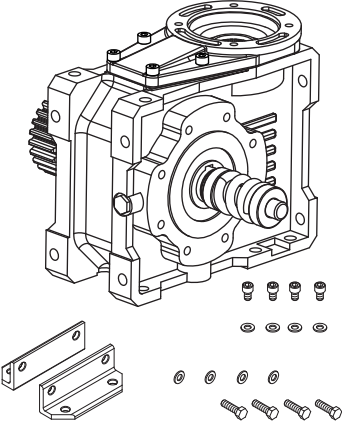
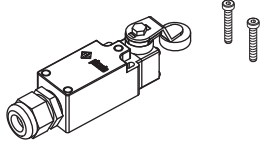
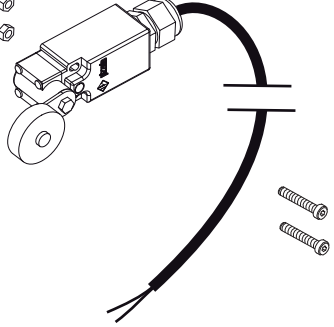



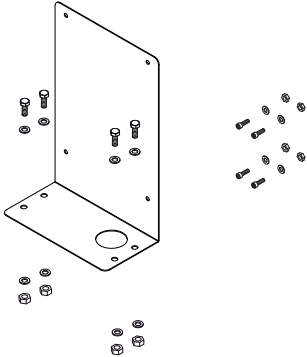
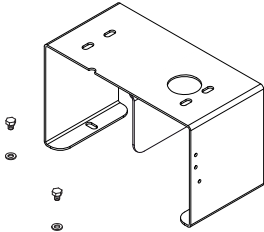
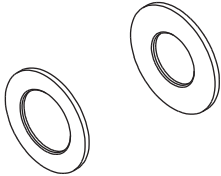
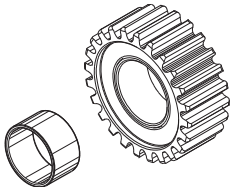



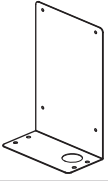

RIF. ARTICOLO	FIGURA	DENOMINAZIONE	CODICE D'ORDINE
40059		Staffa finecorsa sinistra <i>(sostituito con codice d'ordine 30058)</i>	40058
40060		Staffa finecorsa destra <i>(sostituito con codice d'ordine 30058)</i>	40058
40061		Riduttore completo	40061
40062		Finecorsa di comando	40062
40063		Interruttore di stacco bassa tensione con cavo elettrico da 800 mm	40063



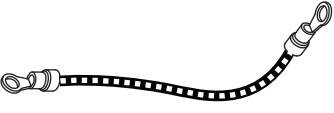

RIF. ARTICOLO	FIGURA	DENOMINAZIONE	CODICE D'ORDINE
40065		Piastra di fissaggio contenitore programmatore completa di art: 1-29-69-70-72-74-75	40065
40066		Supporto quadro di potenza completo di art: 36-46-73	40066
40067		Completo dischi frizione con art: 40-42	40067
40068		Completo ingranaggio con art: 41-47	40068

Le immagini riportate in questo listino sono puramente indicative.



40069		69	Vite M8x20 TE	4	40065
40070		70	Piastra di fissaggio contenitore programmatore	1	40065
40071		71	Dado M5	2	40063
40072		72	Vite M6x20 TEI (n° 4 pz. per fissaggio contenitore programmatore)	4	40065
40073		73	Rondella ø 8 inox	6	40065
40074		74	Rondella ø 6 (per fissaggio contenitore programmatore)	4	40065
40075		75	Dado M6 • per fissaggio contenitore programmatore • per fissaggio cavi di massa a terra	8	40005
40076		76	Cavo di massa a terra con due occhielli 1x6 L = 570 mm (supporto quadro di potenza-portiera)	1	40076
40077		77	Cavo di massa a terra con un occhiello 1x6 L = 570 mm (supporto quadro di potenza-programmatore)	1	40077
40078		78	Rondella dentellata ø 6	4	40005
40079		79	Vite M6x25 TE	2	40005



40080		80	Etichetta adesiva dati tecnici	1	40005
40081		81	Grano M10x10 inox	1	40061
		82			
		83			
		84			
		85			
		86			
		87			
		88			
		89			
		90			

Le immagini riportate in questo listino sono puramente indicative.

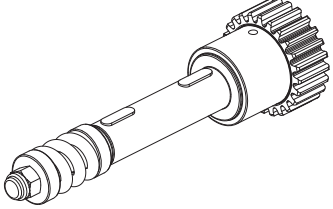

RIF. ARTICOLO	FIGURA	DENOMINAZIONE	CODICE D'ORDINE
400102		Mozzo di trascinamento completo di art: 10-11-12-13-35-38-39-40-41-42-43-47-81	400102

Le immagini riportate in questo listino sono puramente indicative.